



Biostat® B-DCU

The Industry Standard
Bioreactor for Advanced
Process Optimization and
Characterization

Simplifying Progress

SARTORIUS

Introduction

Biostat® B-DCU at a Glance

The Biostat® B-DCU is a fermenter | bioreactor specifically designed to accommodate the broad requirements of process optimization and characterization in the biotech and biopharmaceutical industry. It provides enhanced functionality and an unrivalled level of options for cell culture and microbial processes, making it the ideal scale-down model for your large scale process.



Advanced sensor and software integration

Reveal more information about your process and increase manufacturing efficiency and productivity. Facilitate development of advanced, automated process control strategies to improve titer and quality, and to reduce human error.

Broad range of process control strategies

Mimic your large scale process control approach and generate representative data. Benefit from our fully flexible aeration and feeding options.

Connectivity to supervisory systems

Easily connect your Biostat® B-DCU to our Biobrain® Supervise or third party supervisory software like DeltaV™. Straightforward integration into existing automation infrastructure provides you with data consistency across scales and throughout the entire development process.

Industry standard technologies

Reliable technologies ensure hassle-free process optimization and characterization. Benefit from decades of experience in the biopharmaceutical industry.

Save valuable bench space by equipping your Biostat® B-DCU with up to six bioreactor stations that are controlled independently from each other. Benefit from interchangeability of our Univessel® Glass and Univessel® SU.



Advanced Process Solutions

Scalability and Data Integrity

- Geometrical similarity of vessel design
- Consistent mixing and gassing strategies
- Similar user interface and controllers



Clone Screening | Media and Feed Optimization

Process Development | Process Parameter Optimization

Clinical Trial

Biobrain® Supervise – Turnkey SCADA Solution for

Accelerated process development and process transfer require seamless scalability and integration of process data & controls.

Biobrain® Supervise provides modules to meet your particular requirements. Designed as a “plug-and-play” tool, it is ideally suited for capturing, storing and visualizing process data of your Biostat® B-DCU and other process equipment including 3rd party units.

This software enhances your ability to build your own SCADA network using our preconfigured and bioprocess optimized solution.

The advanced 21 CFR Part 11 compliant Biobrain® Supervise suite is a GAMP category 4 software package capable of supporting the most demanding research or production environment.

Besides the core functionality of a fullfledged SCADA system, Biobrain® Supervise in combination with the BioPAT® DCU is the most cost-effective and flexible platform specifically tailored for bioprocessing applications.



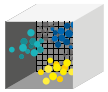

MVDA
Multivariate
Data Analysis

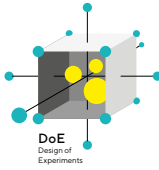

DoE
Design of
Experiments

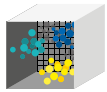

MVDA
Multivariate
Data Analysis

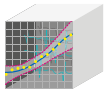

MVDA
Online Multivariate
Data Analysis

Manufacturing

Process Characterization | Robustness Testing

Commercial Manufacturing

Reliable Supervisory Control and Data Acquisition

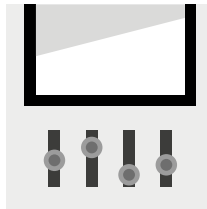
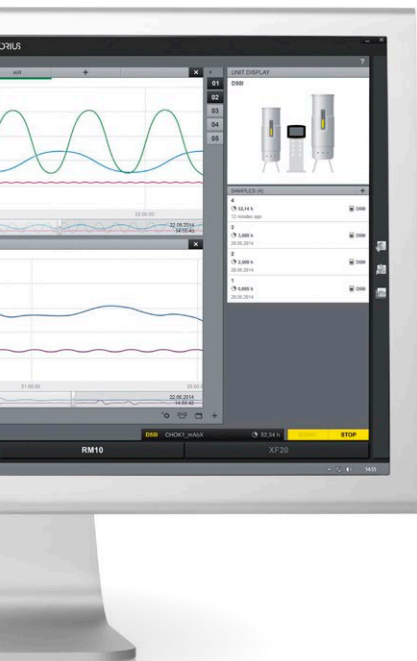

S88 recipe

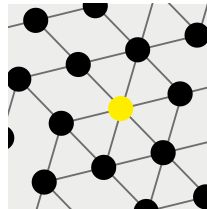

Network

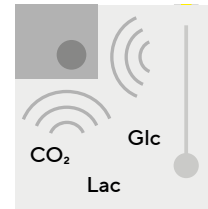

Connectivity



21 CFR Part 11

Advanced Bioreactor Solutions

Freely Configurable

Numerous configurations are available to enable different kinds of process control strategies, which make the Biostat® B-DCU the ideal scale-down and scale-up bioreactor system for all kind of microbial and cell culture processes.

Comfortable operation with a 19" display that can also be operated with gloves

Optional flow meters

Choose up to four variable speed and up to four fixed speed pumps

Manual operation buttons for tube loading | unloading



Connect Univessel® Glass
1 L, 2 L, 5 L and 10 L



Intelligent mass flow controllers with a flow range of 1:200

Connectivity field for connections of sensors, balances and external pumps

Fast load pump heads for fast and secure handling of tubings

Connect your Sartorius Cubis®, Quintix® or Secura® balance and other Sartorius standard balances.

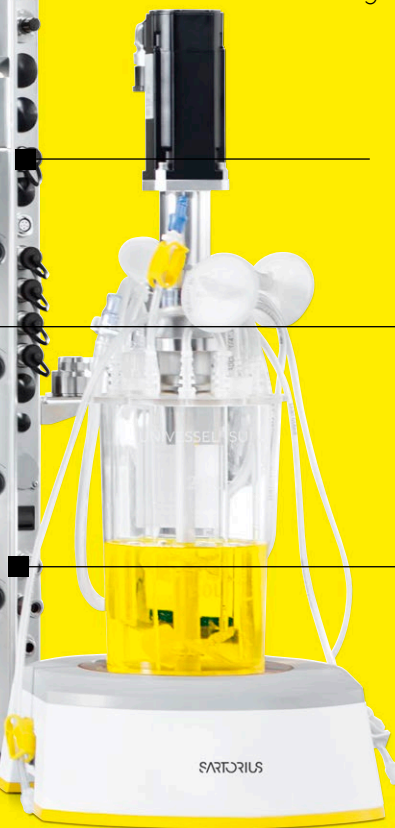

Connect Univessel® SU 2 L

Advanced Aeration Strategies

Freely Configurable Gassing Lines

Intelligent mass flow controllers with a 1:200 flow range give you more flexibility in finding the optimal aeration strategy and enable a higher precision for more reliable and scalable processes. Moreover, not securely closing mass flow controllers are now a thing of the past, making

additional solenoid valves redundant. With mass flow controllers becoming a standard, the importance of flow meters for gas flow monitoring and control is decreasing. You can freely choose, if you want your Biostat® B-DCU gassing lines being equipped with or without flow meters.

Cascade Gassing Control

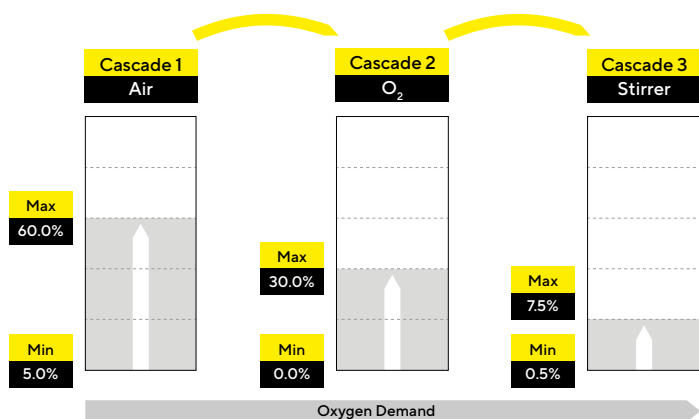

Automatic DO control is one of the most important functionalities of a bioreactor. It is designed to alter the volumetric oxygen transfer rate in order to meet process oxygen demands. As the measured DO moves off the set point, the system will change a parameter (over a defined range) such as the stirrer speed, air flow or oxygen percentage in order to re-establish the DO set point. Each parameter is placed in a cascade order. Once the parameter's limit has been reached the Biostat® B-DCU will shift to the next cascade until reaching the set point.

Advanced DO Control

Constant Gas Flow

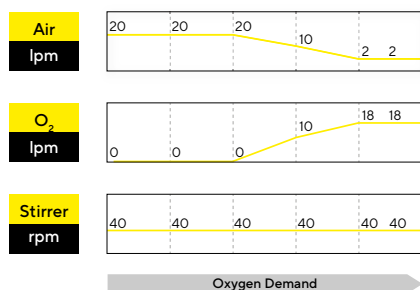

Constant gas flow decreases the flow of air and simultaneously increases oxygen flow keeping the total gas flow constant.

Constant Gas Ratio

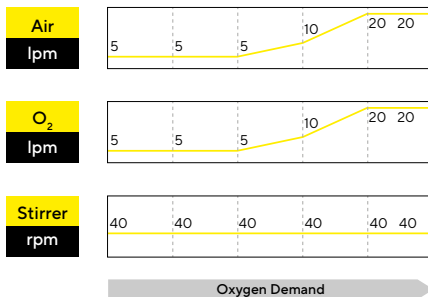

Constant gas ratio, increases both air and oxygen flows at the same rate keeping the ratio constant

Bubble Size Optimization

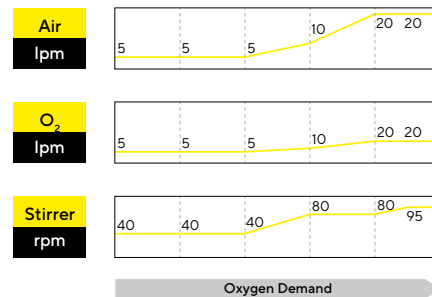

Bubble size optimization enables fine tuning of the oxygen percentage and gas-liquid interface area

Compared to the classic DO control cascade, the advanced DO control allows parallel modification of all physical parameters such as stirrer speed, aeration rate for air | oxygen or other parameters.

This allows simultaneous activation or change of multiple parameters. Therefore, allowing you to perform all gassing strategies and to be resource efficient.

Aeration Modules for Cell Culture

Advanced Additive Flow with outlets for sparger and overlay

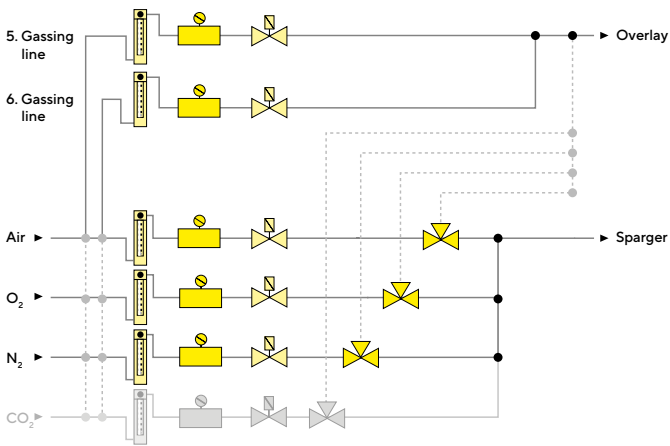

Our Advanced Additive Flow module is available with two gas outlets for sparger and overlay or with a single outlet per gassing line.

This gassing strategy allows to direct air, O₂, N₂ and CO₂ to the sparger and to the overlay. Intelligent mass flow controllers can be installed for each flow path, and gas switching between overlay and sparger is available. Two additional gas flow paths can be freely configured. This enables a maximum in operation flexibility: low flow and high flow aeration applications are possible with the same aeration system.

Advanced Additive Flow with single outlets

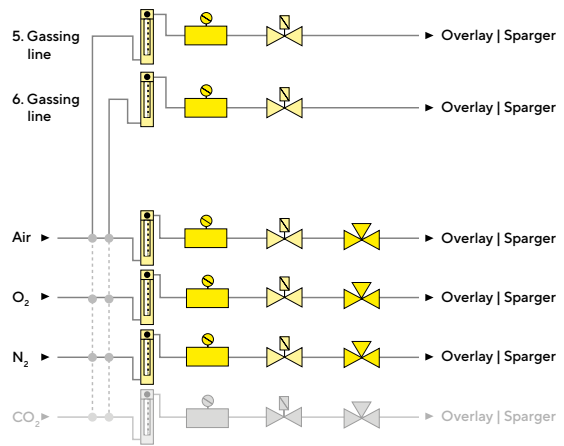

In combination with the new mass flow controller flow range of 1:200, you can run 1 L cell cultivations and 10 L microbial fermentations in the same Biostat® B-DCU system.

The detailed design of the Advanced Additive Flow gassing approach depends on the configuration you select. Please contact your local Sartorius representative for further details.

Aeration Modules for Microbial Fermentation

O₂ Enrichment

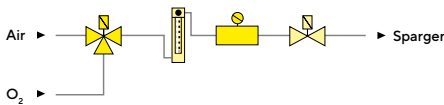

The Additive Flow strategy for microbial applications allows individual flow rate control for air and O₂ to a sparger outlet.

Our O₂ Enrichment module uses a 3 | 2-way solenoid valve to select either an air or O₂ flow to the sparger. O₂ is pulsed via a solenoid valve, when required to maintain the dissolved oxygen setpoint. Air is not provided at this time.

Additive Flow

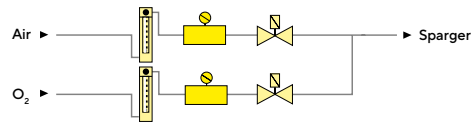

An intelligent mass flow controller can be integrated to measure and control the total gas flow rate via manual adjustment or automatically in conjunction with the controller, based on the signal from the DO probe and the selected setpoint.

Risk is Inverse to Process Understanding

Unlock the superior potential of your Biostat® B-DCU by incorporating our advanced BioPAT® sensor technologies. They enable you to use Process Analytical Technology (PAT) approaches for a maximum in process understanding and for effective automation of your cell cultivation or fermentation process.



BioPAT® Viamass

Determine the viable biomass volume inline and continuously. BioPAT® Viamass is based on the proven principle of capacitance measurement.

- Reduce operator-to-operator variability
- Reduce manual sampling and lower risk of contamination



BioPAT® Trace

The BioPAT® Trace is ideal for simultaneous online monitoring of glucose, lactate and alcohol during cultures of microorganisms or animal cells.

- Fully disposable sensor and fluidics set for easy setup and immediate use
- Fast concentration determination without any loss of volume



BioPAT® Xgas

Precisely track O₂ | CO₂ concentration changes in respiratory gas emission from a cultivation vessel with the compact BioPAT® Xgas.

- Highest accuracy by automatic moisture and pressure compensation
- Compact design and parallel measurement in a single analyzer saves space in your lab

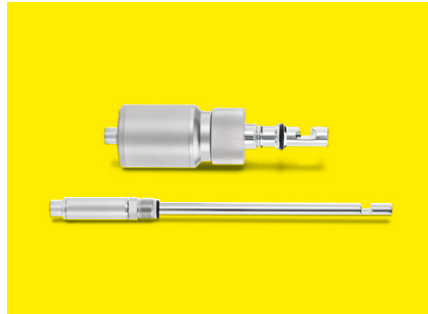

BioPAT® Fundalux

The BioPAT® Fundalux turbidity systems are based on an integrated absorption-based probe using near infrared light for total biomass determination.

- Range of optical path lengths (1, 5 and 10 mm) yields optimal total biomass coverage for your specific process
- Robust LED light source with up to 10-year lamp lifetime



Hamilton Arc (pH | DO)

The Arc μ-transmitter located in the sensor head stores all relevant sensor data, including calibration and diagnostic information.

- Digital pH and DO sensors provide more reliable signals than traditional analog sensors, e.g. eliminate signal noises
- Maintenance-free pressurized pH sensor
- Optical VisiFerm outperforms traditional polarographic sensors in terms of measurement performance and maintenance
- Optional automatic GMP reporting, wireless monitoring with ArcAir mobile

Advanced Process Control Solutions

Cell Cultivation

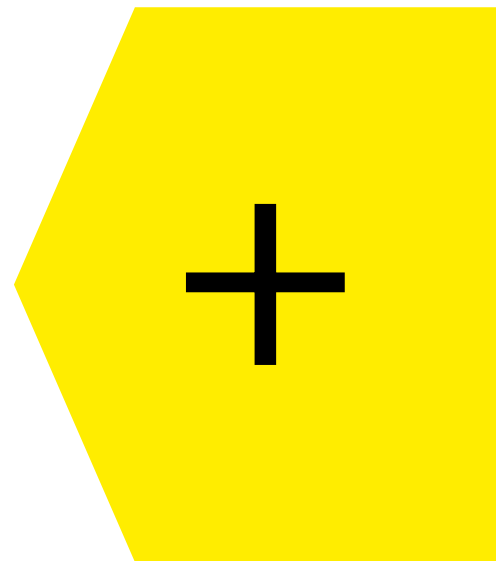
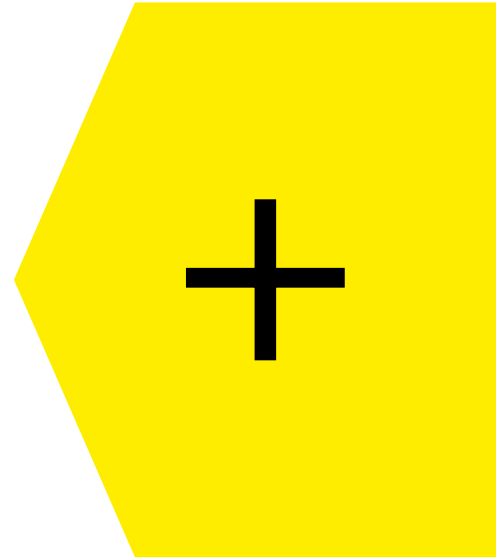

Control of Glucose Concentration



- Control the glucose level with the local control software of the Biostat® B-DCU
- Automated glucose set point control
- Establish profiles for your glucose concentration set point
- Monitor lactate concentration directly on the local control screen of your DCU
- Select up to four variable speed pumps for substrate addition
- Create advanced control loops based on glucose and lactate concentration
- Develop your specific process strategy for event-based glucose feeds

Control of Perfusion Processes



- Operate the BioPAT® Viamass probe without any external software
- Monitor the viable cell volume directly on the local control screen of your DCU
- Make information about the viable cell volume available to supervisory control software
- Implement advanced perfusion control strategies, e.g. via automatic control of feeds and bleeds
- Robust and reliable determination of time of harvest or transfer of inoculum

Biobrain® Supervise



Parameter optimization and robustness testing with BioPAT® MODDE and Biobrain® Supervise



- Increase efficiency of bioprocess development, reduce project timelines and support Quality by Design (QbD) programs.
- Transfer your designed parameter setpoints automatically to your Biobrain® Supervise
- Our DoE module for Biobrain® Supervise ensures reliable and seamless integration of DoE procedures into control strategies.

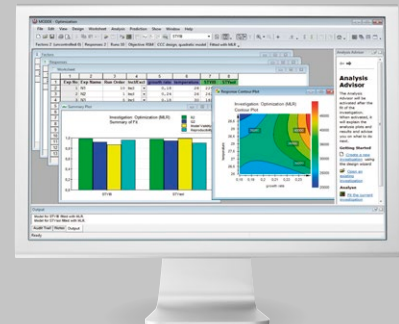

Advanced Process Control Solutions

Microbial Fermentations

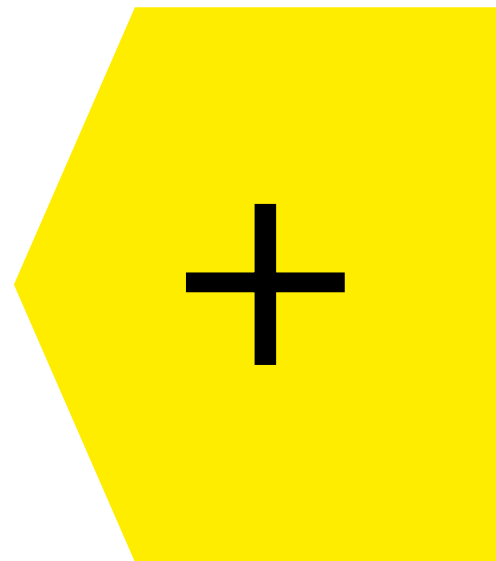
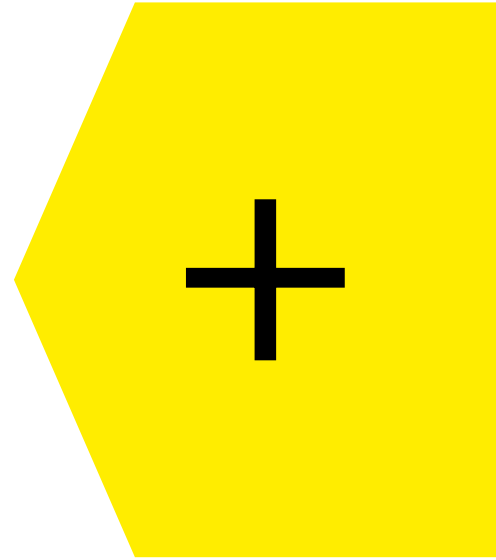

Metabolic Respiration Control



- High precision of gas flow control by intelligent mass flow controllers
- Realtime monitoring of exhaust gas is directly available in your Biostat® B-DCU
- Facilitate insights into critical metabolic changes during your fermentation process
- Ensure optimal growth conditions, ultimately increasing the productivity of your process
- Obtain an automatic calculation of oxygen uptake rate, carbon dioxide evolution rate and respiratory quotient
- Apply reliable, advanced gassing or feeding strategies to improve production rates and reduce cultivation time
- Receive a complete batch record of O₂ | CO₂ in the off-gas to reveal more information about your process

Control of Glucose, Ethanol and Methanol Concentration

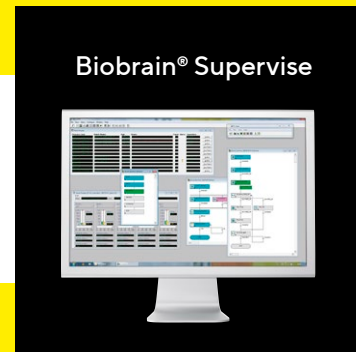

- Monitor glucose, ethanol or methanol levels with the local control software of the Biostat® B-DCU
- Automated glucose set point control
- Establish profiles for the glucose concentration set point
- Select up to four variable speed pumps for substrate addition
- Create advanced control loops based on glucose, ethanol, or methanol concentration
- Develop your specific event-based control strategies

Parameter optimization and robustness testing with BioPAT® MODDE and Biobrain® Supervise



- Increase efficiency of bioprocess development, reduce project timelines and support Quality by Design (QbD) programs.
- Transfer your designed parameter setpoints automatically to your Biobrain® Supervise
- Our DoE module for Biobrain® Supervise ensures reliable and seamless integration of DoE procedures into control strategies.

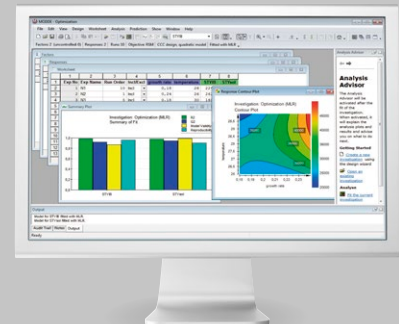

Advanced Process Characterization Solutions

The Optimal Scale Down Model

“Small-scale models can be developed and used to support process development studies. The development of a model should account for scale effects and be representative of the proposed commercial process.”

ICH Q11 Step 4

Seamless scalability from early process development to commercial production

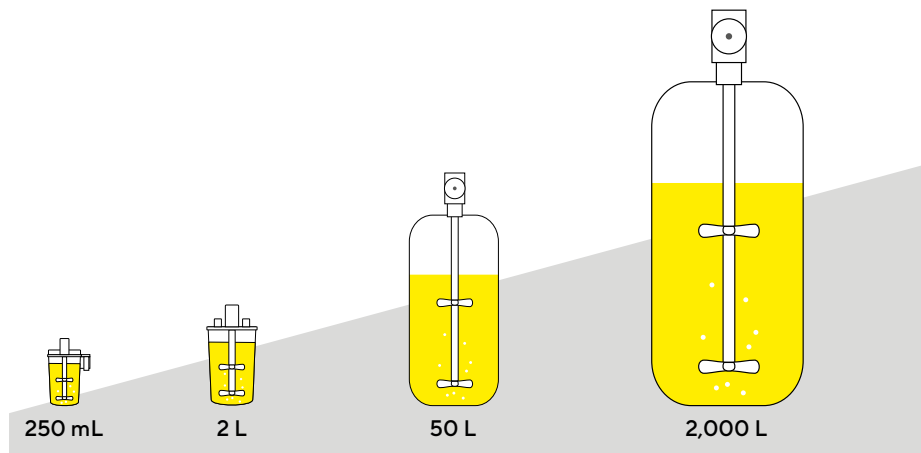

Classic, stirred-tank design and geometric similarity of our range of bioreactors from bench scale to production scale.

Emulate control strategies of your production scale bioreactor in benchtop scale with our Biostat® B-DCU

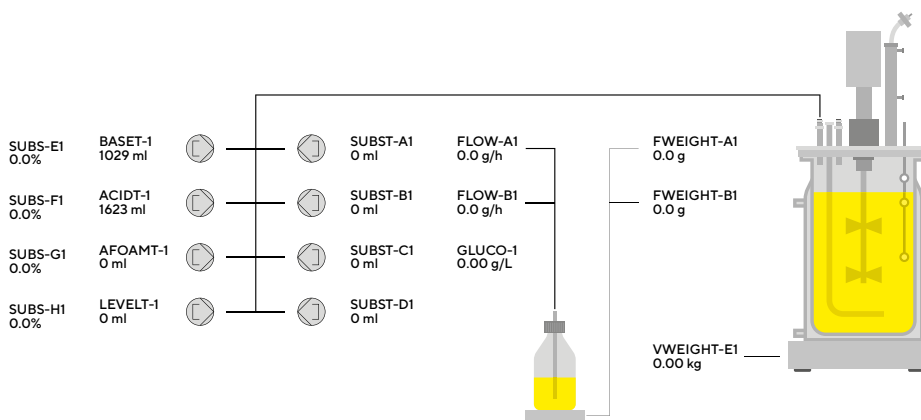

- Similar sensor technologies in benchtop scale and in manufacturing scale
- High flexibility in gas mixing strategies in combination with smart mass flow controllers. Learn more about our aeration strategies on pages 8 ff.
- Select up to four substrate addition lines with integrated, wide range variable speed pumps to mimic production scale feeding strategies

“It is important to understand the degree to which models represent the commercial process, including any differences that might exist, as this may have an impact on the relevance of information derived from the models.”

FDA Process Validation Guidance



Process characterization made easy with Biostat® B-DCU and our BioPAT® Chemometrics Toolbox

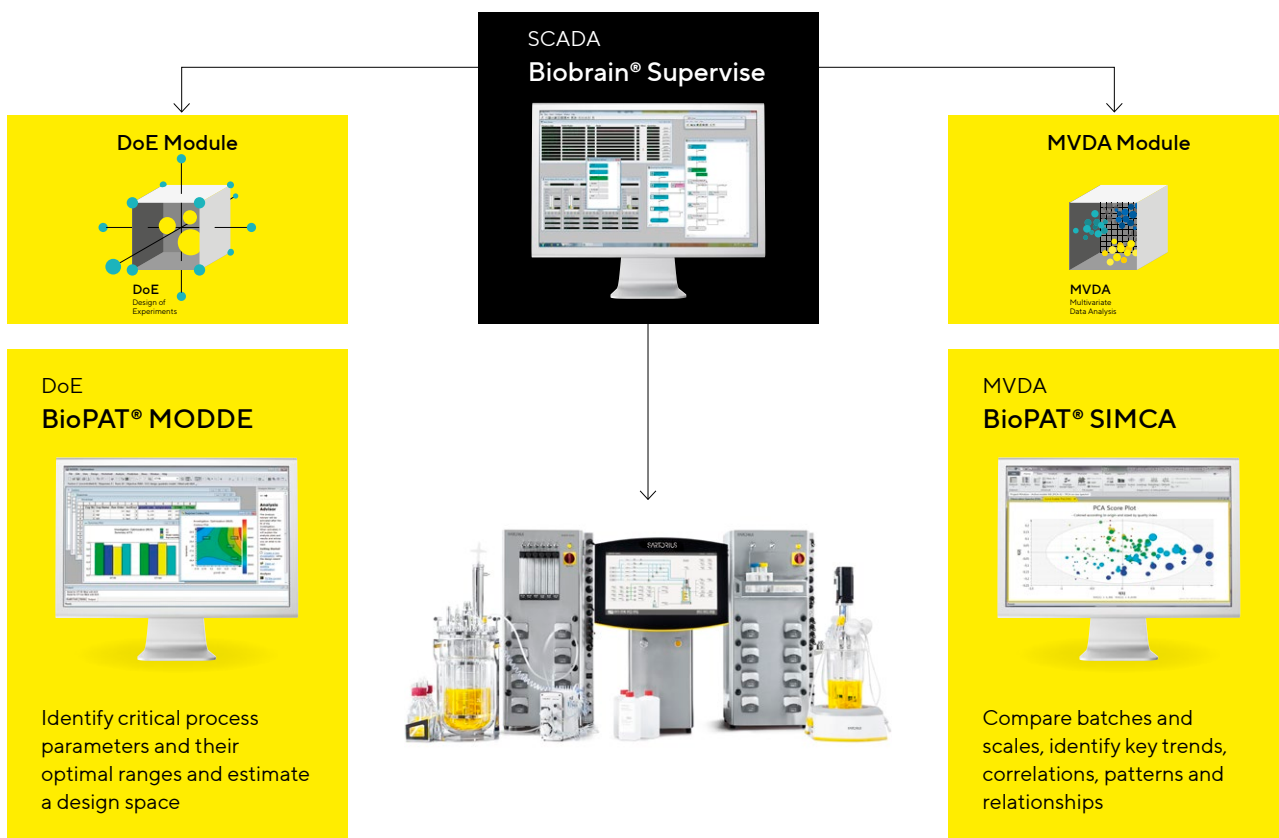

Take advantage of the BioPAT® Chemometrics Toolbox and integrate advanced multivariate methods into your process control software BioPAT® MFCS | win.

Transfer data from your Biostat® B-DCU to BioPAT® MODDE and SIMCA in order to reduce effort associated with data management and comparison of current and historical batches.

- Unlock process understanding to ultimately improve the quality, safety and efficiency of your drug product.

Advanced Communication Options

Integration and Connectivity at Its Best

If you need data acquisition or want full control of your Biostat® B-DCU by your supervisory control and data acquisition system (SCADA) or distributed control system (DCS), the Biostat® B-DCU provides the right interfaces and tools to connect to.



Biobrain® Supervise – Turnkey SCADA Solution

Specialized for bioprocesses, Biobrain® Supervise is designed as a “plug-and-play” tool for advanced SCADA functionalities.

It is ideally suited for capturing, storing and visualizing process data of all Biostat® and Ambr® bioreactors and other process equipment.

One source bundle with full Sartorius responsibility and lifecycle concept

Specifically tailored for biopharmaceutical industry

Cost-effective & flexible automation platform



Setpoints | Actuator Access

DCU Modbus fieldbus | DCU OPC interface

Process Values | Alarms

Siemens Simatic
PCS 7

Rockwell
Automation

Emerson Process
Management
DeltaV™

For the straightforward integration of your Biostat® B-DCU into a DeltaV™ network, we provide a Modbus mapping of your system in digital format. Once imported into your

DeltaV™ configuration it enables you to access process values, set controller parameters or even access actuators in a direct manner – e.g. pumps or valves.

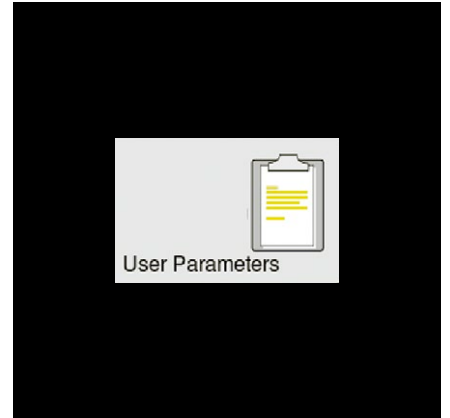
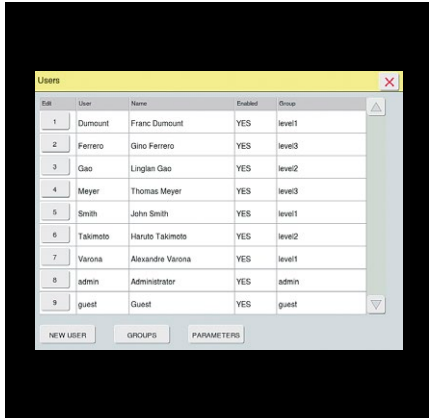

Centralized User | Password Management Utilizing Windows® Domain Login

Central management of user rights for your bioprocess equipment has never been easier – the Biostat® B-DCU can connect directly to your user management data implemented on your Microsoft® Server and your user can work with their well-known user names and passwords.

Import and Export Process Relevant Settings of Instruments

Easily store your individual process settings and user authentication data and transfer them between Biostat® B-DCU instruments.

The Biostat® B-DCU has the tools to smoothly integrate into your individual control & IT infrastructure.

Microsoft® and Windows® are registered trademarks of Microsoft Corporation, USA.

Advanced Services

Maximized Process Security

To keep your biopharmaceutical process robust and reliable, we provide a comprehensive range of services to ensure the highest reliability and uptime of your Biostat® B-DCU, regulatory compliance and best quality of results.

From installation and qualification to regular preventative maintenance: Our service team will be happy to assist you on site and will be with you quickly thanks to our worldwide service network.



Installation and Commissioning
Safe and proper operation of your equipment - right from the start



Qualification (SAT)
Compliance with GMP requirements, easy integration into your quality management system



Operator Training
Quality through greater expertise: Sartorius trains the personnel operating our equipment

Installation Phase

Utilization Phase



Repairs and Spare Parts
In the event of service requests, we are quickly at your side with the necessary spare parts - worldwide



Maintenance and Contracts
Optimal equipment operation and protection against potential downtimes



















Calibration
Accurate results in the long term and compliance with regulatory requirements



Service Contracts for the Entire System Lifecycle

With our Bioprocess Service Program, Sartorius offers service contracts to protect your equipment through its entire lifetime. Based on your specific risk assessment and requirements, you can choose between three Service Level Agreements: Essential, Advanced and Comprehensive. Protect your Biostat® B-DCU by choosing the appropriate service contract. For maximum productivity and minimum downtimes.

	Essential	Advanced	Comprehensive
You benefit from:	<ul style="list-style-type: none"> ▪ A plannable annual maintenance ▪ A fast support at the technical helpdesk within one business day and priority on-site-response ▪ In case of repair: a discount on all time and material based cost elements 	<ul style="list-style-type: none"> ▪ A plannable annual maintenance ▪ Technical helpdesk reaction time within 8 hours and 72 hours on-site response ▪ In case of repair: labor and travel costs are covered, a discount of 10% on spare parts 	<ul style="list-style-type: none"> ▪ A plannable annual maintenance ▪ Technical helpdesk reaction time within 4 hours and 48 hours on-site response ▪ In case of repair: all costs are covered

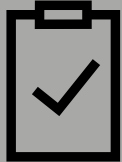
	Essential	Advanced	Comprehensive
Reaction time			
Repair	   	   	   
Maintenance			

Your Benefits

- Process stability and minimized downtime
- Maximized system uptime, higher profitability
- Optimized total cost of ownership

Technical Specifications

Technical Specifications

Control Tower

General

Weight	ca. 30 kg (ca. 66 lbs)
Dimensions (W×H×D)	490 mm × 730 mm × 535 mm (19.3" × 28.7" × 21.1")
Power supply	<ul style="list-style-type: none">▪ 100 – 240 V, 50 – 60 Hz, max. power consumption 4 A▪ Potential equalisation
Housing	<ul style="list-style-type: none">▪ Stainless steel, AISI 304 EN 10020 1.4301▪ International protection rating: IP 30
Display	<ul style="list-style-type: none">▪ Touch screen, 19", glass, capacitive▪ Resolution: 85 dpi
SCADA communication	<ul style="list-style-type: none">▪ Industrial Ethernet (standard)▪ Modbus TCP (optional)
Interfaces	<ul style="list-style-type: none">▪ USB▪ Ethernet▪ Potential-free alarm contact▪ 6 × interfaces to supply towers
Regulatory compliance	CE, NRTL recognized by the U.S. OSHA (Occupational Safety and Health Administration)



Supply Tower

General

Weight	ca. 45 kg (99 lbs); depends on configuration	
Dimensions (W×H×D)	360mm×768mm×432mm (14.2"×30.2"×17.0")	
Power supply	<ul style="list-style-type: none"> ▪ 230 V (± 10%), 50 Hz, max. power consumption 10 A ▪ 120 V (± 10%), 60 Hz, max. power consumption 12 A ▪ Average power consumption during cell cultivation (incl. control tower): ~ 190 kWh ▪ Potential equalisation 	
Housing	<ul style="list-style-type: none"> ▪ Stainless steel, AISI 304 ▪ International protection rating: IP 30 	
Gases	<ul style="list-style-type: none"> ▪ Gas supply pressure 1.5 barg (22 psi) ▪ Gases must be dry, oil and dust-free ▪ Hose barbs for tubings with Ø internal = 3.2 mm (0.13"); hose barbs removable for direct push-in connection of gas hoses with Ø external = 6 mm (0.24") 	
Water	<ul style="list-style-type: none"> ▪ Water supply pressure: 2 – 4 barg ▪ Flow rate up to 20 lpm ▪ Temperature min. = 4°C ▪ Discharge pressure-less ▪ Hose barb for tubings with Ø internal = 8 mm (0.31") ▪ Degree of hardness: 12° dH max. ▪ Integrated water pressure reduction down to: 1.5 barg (22 psi) 	
Interfaces	<ul style="list-style-type: none"> ▪ 3 × external signal inputs 0 – 10 V ▪ 3 × external signal inputs 4 – 20 mA ▪ Interface to control tower ▪ Fieldbus for serial or ethernet devices ▪ Digital output 24 V for on off control of external devices ▪ Up to 4 analogue outputs for external pumps ▪ Connection for control of external drive motor (0 – 10 V) ▪ Further interfaces depend on configuration 	
Regulatory compliance	CE, NRTL recognized by the U.S. OSHA (Occupational Safety and Health Administration)	

Motor drive

Maintenance-free, quiet direct drive	Power: 200 W (400 W optional)	
Maintenance-free top drive with magnetic motor coupling	Power: 200 W (400 W optional)	
Rotation speed motor, direct coupling	1L Glass: 20 – 2,000 rpm 2L Glass: 20 – 2,000 rpm 5L Glass: 20 – 1,500 rpm	10L Glass: 20 – 800 rpm 2L Single-use: 20 – 400 rpm
Rotation speed motor, magnetic coupling	1L Glass: 20 – 2,000 rpm 2L Glass: 20 – 2,000 rpm	5L Glass: 20 – 1,500 rpm 10L Glass: 20 – 800 rpm

Process Control | Sensors

	Sensor Measurement Range Display Resolution	Univessel® Glass	Univessel® SU
Temperature	Pt100 0–150°C (temperature control 0–80°C) 0.1°C	■	■
Dissolved oxygen, reusable	Polarographic or optical 0–100% 0.1%	■	■
Dissolved oxygen, single-use	DO sensor patch 0–100% 0.1%		■
pH, reusable	Combined measuring electrode 2–12 pH 0.01 pH	■	■
pH, single-use	pH sensor patch 6.5–8.5 pH 0.1 pH		■
Foam control	Electrical conductive sensor, stainless steel, ceramic insulated	■	
Level	Electrical conductive sensor, stainless steel, ceramic insulated	■	
Turbidity	1-channel NIR absorption sensor 0–6 AU 0.01 AU	■	
Redox	Combined measurem. with pH sensor –1,000–1,000 mV 1 mV	■	■
Balance substrate	7 kg (15.4 lbs) max. 1 g (0.035 oz) 60 kg (132.3 lbs) max. 10 g (0.35 oz)	■	■
Balance culture vessel	60 kg (132.3 lbs) max. 10 g (0.35 oz)	■	■
Gravimetric flow controller	Accuracy for 7 kg balance: 5 g/h Accuracy for 60 kg balance: 50 g/h	■	■
Pressure measurement	Pressure 0–1,000 mbarg (control range: 0–500 mbarg) 1 mbar	■	
Glucose	Enzymatic sensor 0–40 g/L 0.01 g/L	■	■
Lactate	Enzymatic sensor 0–10 g/L 0.01 g/L	■	■
Viable biomass	Capacitance sensor 0–400 pF/cm or 0–400 E ⁶ cells/mL 0.1 pF/cm or 0.01 E ⁶ cells/mL	■	
O ₂ offgas	Zirconium dioxide 0–50 vol% 0.1 vol%	■	■
CO ₂ offgas	Infrared 0–10 vol% 0.1 vol%	■	■

Aeration Module

Dimension outlets to culture vessel	Hose barbs for tubings with d internal = 3.2 mm (0.13"); removable for direct push-in connection of gas hoses with d external = 6 mm (0.24")
-------------------------------------	---

Univessel® Glass MO (Microbial)**Two-gas mixing with sparger outlet**

O₂ Enrichment or Additive Flow 2-Gas (Gas Flow Ratio) aeration modules;
for further information, please see pages 8 ff. on "Aeration Strategies"

Gas outlets	1
Max. total flow	Up to 20 lpm per gassing line
Mass flow controllers	Up to 2
Range of mass flow controllers	1 : 200
Accuracy of mass flow controllers	± 0.3% full scale + ± 0.5% current value
Flow meters	Up to 2
Range of flow meters	1 : 10
Accuracy of flow rate controllers	± 5% full scale
Solenoid valves	Up to 2

Univessel® Glass CC (Cell Culture) |**Univessel® SU****Four-gas mixing with sparger and headspace outlet**

Additive flow 4-gas (Air, O₂, N₂, CO₂) aeration module plus optional 5th and 6th aeration line;
for further information, please see pages 8 ff. on "Aeration Strategies"

Gas outlets	2 (sparger overlay) or single gas outlets per gassing line
Max. total flow	Up to 20 lpm per gassing line
Gas switching valves sparger to overlay (only for aeration module with 2 gas outlets)	Up to 4
Mass flow controllers	Up to 6
Range of mass flow controllers	1 : 200
Accuracy of mass flow controllers	± 0.3% full scale + ± 0.5% current value
Flow meters	Up to 6
Range of flow meters	1 : 10
Accuracy of flow rate controllers	± 5% full scale
Solenoid valves	Up to 6

Pump Module

Pump heads

Watson Marlow 114, fast load pump head

Built-in pumps

Flow rate (tubing wall thickness 1.6 mm)

Fixed speed (on | off controlled)
Speed 5 rpm

Int. dia.: 0.5 mm (0.2"): 0–0.1 mL/min
Int. dia.: 0.8 mm (0.31"): 0–0.2 mL/min
Int. dia.: 1.6 mm (0.63"): 0.01–0.7 mL/min
Int. dia.: 2.4 mm (0.94"): 0.03–1.5 mL/min
Int. dia.: 3.2 mm (1.26"): 0.05–2.4 mL/min
Int. dia.: 4.8 mm (1.89"): 0.09–4.3 mL/min

Fixed speed (on | off controlled)
Speed 44 rpm

Int. dia.: 0.5 mm (0.2"): 0.02–0.9 mL/min
Int. dia.: 0.8 mm (0.31"): 0.04–1.8 mL/min
Int. dia.: 1.6 mm (0.63"): 0.12–6.2 mL/min
Int. dia.: 2.4 mm (0.94"): 0.26–12.8 mL/min
Int. dia.: 3.2 mm (1.26"): 0.41–20.7 mL/min
Int. dia.: 4.8 mm (1.89"): 0.75–37.4 mL/min

Speed-controlled in low speed mode
Speed 0.15–5 rpm

Int. dia.: 0.5 mm (0.2"): 0–0.1 mL/min
Int. dia.: 0.8 mm (0.31"): 0.01–0.2 mL/min
Int. dia.: 1.6 mm (0.63"): 0.02–0.7 mL/min
Int. dia.: 2.4 mm (0.94"): 0.04–1.5 mL/min
Int. dia.: 3.2 mm (1.26"): 0.07–2.4 mL/min
Int. dia.: 4.8 mm (1.89"): 0.13–4.3 mL/min

Speed-controlled in high speed mode
Speed 5–150 rpm

Int. dia.: 0.5 mm (0.2"): 0.1–3 mL/min
Int. dia.: 0.8 mm (0.31"): 0.2–6 mL/min
Int. dia.: 1.6 mm (0.63"): 0.7–21 mL/min
Int. dia.: 2.4 mm (0.94"): 1.45–43.5 mL/min
Int. dia.: 3.2 mm (1.26"): 2.35–70.5 mL/min
Int. dia.: 4.8 mm (1.89"): 4.25–127.5 mL/min

External pumps

Speed-controlled

Watson Marlow WM120
Fast load pump head
Up to 200 rpm, speed range selectable
Speed range controllable by DCU = 1 : 100

Temperature Control Module

For Univessel® Glass Single-wall Culture Vessels

- Electrical heating system and automatic cooling water valve; connection to heating blanket and cooling finger
- Temperature control of 8°C above cooling-water inlet temperature up to 60°C
- Heating blanket capacities
1L | 2L | 5L | 10L:
100 | 170 | 400 | 780W

For Univessel® Glass Double-wall (Jacketed) Culture Vessels

- Open thermostat system with recirculation pump and automatic cooling water valve
- Temperature control of 8°C above cooling-water inlet temperature up to 80°C
- Heating capacity: 1,000W

For Univessel® SU Single-use Culture Vessels With Heating Blanket

- Electrical heating blanket
- Temperature control up to 50°C
- Heating capacity 2L: 200W

For Univessel® SU Single-use Culture Vessels With Heating | Cooling Water Jacket

- Open thermostat system with recirculation pump and automatic cooling water valve; connection to heating | cooling jacket
- Temperature control up to 50°C
- Heating capacity: 1,000W



Germany

Sartorius Stedim Biotech GmbH
August-Spindler-Strasse 11
37079 Goettingen
Phone +49 551 308 0

USA

Sartorius Stedim North America Inc.
565 Johnson Avenue
Bohemia, NY 11716
Toll-Free +1 800 368 7178

 For further contacts, visit
www.sartorius.com